



Creating balance in healthcare



## Instructions for use Elexo XXL Shower-toilet chair



# Instructions for use

## Elexo XXL

5100 5300

**Shower-toilet chair**

Basic UDI-DI : 872025610316551005300JX



 **lopital**<sup>®</sup>  
Creating balance in healthcare

## Important:

Read these instructions carefully before using the Elexo XXL!

Date first used .....

User .....

Name .....

Address .....

## Manufacturer

Lopital Nederland B.V.

Laarakkerweg 9















5061 JR Oosterwijk

T +31 (0)13 5239300

www.lopital.nl

info@lopital.nl

All of the aids produced by Lopital fulfil the following norms for medical products Class 1 (MDR (EU) 2017/745).

Explanation of symbols in 'instructions for use' and on labels			
	<b>Note</b>		<b>Follow the instructions for use</b>
	<b>Applied parts</b>		<b>Read cleaning and disinfecting protocol</b>
	<b>Direct current 24V DC</b>		<b>Antibacterial</b>
	<b>Class 2 EMC</b>		<b>Temperature</b>
	<b>Date of production</b>		<b>Air pressure</b>
	<b>Maximum load</b>		<b>Humidity level</b>
	<b>Global trade identification number</b>		<b>Serialnumber</b>

# Contents

1.	Introduction .....	5
1.1.	Introduction .....	5
1.2.	Safety.....	5
1.3.	Warranty.....	7
2.	Use.....	10
2.1.	First use.....	10
2.2.	Activating.....	10
2.3.	Working with the Elexo XXL.....	11
3.	Operation .....	12
3.1.	Wheel blocking.....	12
3.2.	Directional wheel.....	12
3.3.	Footrests.....	12
3.4.	Armrests.....	13
3.5.	Moving upwards / downwards.....	13
3.6.	Toilet function.....	14
3.6.1.	In combination with toilet.....	14
3.6.2.	Use of a bedpan or bucket.....	14
3.7.	Removable seat .....	15
3.8.	Charging batterie .....	15
4.	Safety functions .....	17
4.1.	Emergency stop.....	17
4.2.	Sleep setting.....	17
4.3.	Emergency lowering.....	17
4.4.	On / off switch.....	18
5.	Cleaning and maintenance .....	18
6.	Environmental conditions.....	20
7.	Removal of parts.....	20
8.	Technical specifications .....	21
8.1.	Structure.....	21
8.2.	Drive .....	21
8.3.	Dimensions .....	21
9.	Electromagnetic compatibility.....	24

# 1. Introduction

## 1.1. Introduction

The Elexo XXL electric height-adjustable shower-toilet chair is an aid for the ergonomic care and washing of the client. For both the client and the carer, the comfort is optimal. The Elexo XXL can be used with a commode pan / bucket or in combination with a toilet, can also be used as a toilet seat.

The Elexo XXL consists of a base and a chair section. The seat section has the same comfort as a normal chair and offers the same proper support. There are no essential performances.



The frame of the Elexo XXL has an antibacterial coating. The coating contains silver ions. Antibacterial coating based on silver ions prevents dangerous micro-organisms such as bacteria, fungi and algae multiply and spread. The effectiveness was confirmed in several tests. Germs were demonstrably reduced in a short time to 99.99%.

The coating only affects bacteria that are found on the surface and not on airborne micro-organisms. The coating protects users or others from disease-causing bacteria, germs, viruses or other harmful organisms. On a dirty surface, the coating loses its antibacterial properties. So proper cleaning and disinfection is still a must.

The expected technical lifetime of the Elexo XXL is 10 years, provided that daily and periodic maintenance is carried out according to the specified maintenance schedule (*See chapter 5. Cleaning and maintenance*).

*The Elexo XXL is a medical class 1 product with CE marking. This marking is in accordance with the regulation MDR (EU) 2017/745. The Elexo XXL is tested for electromagnetic radiation according to the 60601-1-2 standard.*

## 1.2. Safety



**A failure to comply with the following safety points and the further definitions in these instructions for use could lead to hazardous situations. Please read carefully before use.**

## *Use*

- Before you start working with the Elexo XXL, check that it has been disconnected from the charger.
- The Elexo XXL will fall into standby mode after a few seconds when the chair is not in use.
- Make sure the Elexo XXL brake is applied before transferring clients.
- Notify the client before moving the Elexo XXL.
- To avoid entrapment, do not place your feet on the lower frame when raising, lowering or tilting the seat.
- Close the armrests before moving the Elexo XXL upwards.
- Make sure that the client always places his/her arms on the armrests provided to prevent possible entrapment.
- Make sure that the armrests are locked when moving the Elexo XXL.
- Be aware of obstacles when moving upwards and downwards.
- Only relocate and move the Elexo XXL in the lower position.
- When moving the Elexo XXL, do not adjust upwards or downwards.
- Always try to move backwards over obstacles (rather than forwards).
- Set the Elexo XXL to the correct height before using with a toilet.
- It is not permitted to charge the Elexo XXL with more than 220 kg / 485 lbs.
- The Elexo XXL is only suitable for moving and caring for one person.
- Only use original parts, supplied by Lopital.
- The use of components (chargers, cables, actuators, batteries, etc.) that have not been supplied by Lopital may result in increased emissions or decreased immunity of the Elexo XXL.
- Use the Elexo XXL in a clean and tidy working environment.
- Only verifiably authorised personnel is allowed to work with the Elexo XXL.
- Charge batteries in a well-ventilated, dry space.
- Swimming pool locations are not considered to be 'normal conditions' and will substantially shorten the lifespan of certain components.
- The Elexo XXL cannot be used on a surface with a gradient over 5 degrees laterally.
- The Elexo XXL cannot be used on a surface with a gradient of over 10 degrees forwards / backwards.
- The Elexo XXL may only be used indoors.
- Portable and mobile RF communication equipment can affect medical devices.
- Medical electrical devices involve special EMC precautions and must be used as per the EMC information outlined in the instructions for use.
- The chair must not be used adjacent to or stacked on other products. However, should that be necessitated, it must be checked whether the chair functions normally in this configuration too.

### *Maintenance*

- If the charger or cable become damaged, they must be replaced.
- In the event of damage to the seat, back or backrest, always replace them for reasons of hygiene.
- The Elexo XXL must be inspected and serviced at least once a year.
- Servicing and maintenance of the Elexo XXL may only be carried out by persons authorised by Lopital.
- Service and maintenance must not be carried out while a client is sitting on the chair.
- If erroneous use, transport, an accident or improper maintenance leads to deformation of the Elexo XXL, it may no longer be used and you must contact the supplier.

In the event of breakdowns, you must contact Lopital or your local supplier.

E-mail: [info@lopital.nl](mailto:info@lopital.nl)



**The Elexo XXL shower-toilet chair should only be operated by competent personnel who have experience in working with the user target group and have watched the instruction/training videos on the Lopital website.**



**The Elexo XXL has been developed and produced for use in a professional healthcare environment.**



**Making changes to the construction may affect the safety of the Elexo XXL. Furthermore, the liability and guarantee conditions of Lopital lapse. As a result, the Elexo XXL no longer complies with the MDR (EU) 2017/745 regulation for medical devices.**

### **1.3. Warranty**

All Lopital products are supplied with a 2-year warranty, on construction and / or material faults, unless otherwise stated. In the event of varying warranty terms, the exact period will be indicated on your invoice; this also serves as the warranty itself. Components and batteries that are subject to wear and tear will not fall under warranty unless there are clear construction and / or material faults.

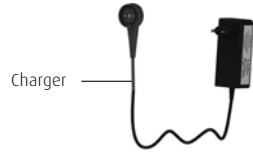
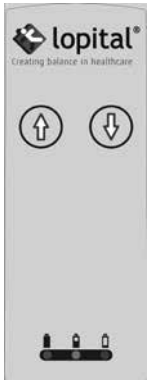



Figure 1 Activating.







**lopital**  
 Laanaktievweg 9  
 5061 JR Oisterwijk  
 The Netherlands  
 T: (+31)13-5239300  
 IP-

GTIN (01) 8720256103---  
 (11) YYMMDD  
 SN (21) -----

CE  
 Weight: -- kg / -- lbs  
 Type battery: --  
 Drive operates: --V  
 Charge: --V-- mA  
 Non-Continuous: --

MAX  
 LOAD  
 -- kg / -- LBS  
 Product type

Item no: -----





  
 Scan for  
 information

Tested to:  
 UL 60601-1:2005/A2:2010/(R)2012  
 CAN/CSA-C22.2 No. 60601-1:14  
 E 114029



## 2. Use

### 2.1. First use

On page 8 you can find the components of the Elexo XXL. These components are the applied parts of the Elexo XXL. These components may come into contact with the user(s) while the Elexo XXL is in use.

### 2.2. Activating

The Elexo XXL must be activated before use, which can be done by pressing any button on the manual control for 2 seconds (*See figure 1*).

It may occur that the Elexo XXL goes into sleep mode after a period of time.

To deactivate the sleep mode, press any button on the hand control for 2 seconds.



**Activate the Elexo XXL by pressing any button for 2 seconds.**

## 2.3. Working with the Elexo XXL

### Step 1

Disconnect the Elexo XXL from the charger if necessary.

### Step 2

Activate the Elexo XXL (See paragraph 2.2. Activating).

### Step 3

If necessary, turn the armrests downwards (See paragraph 3.4. Armrests).

### Step 4

If necessary, turn the footrests away (See paragraph 3.3. Footrests).

### Step 5

The Elexo XXL must be put on the brakes before transferring persons (See paragraph 3.1. Wheel blocking).

### Step 6

The client can take a seat in the chair. Support the client if necessary.

### Step 7

Place both feet on the footrests and calves against the calf-supports (See paragraph 3.3. Footrests).

### Step 8

Close the armrests once the client has taken a seat in the chair (See paragraph 3.4. Armrests).

### Step 9

Notify the client about the processes you will be carrying out.

### Step 10



Take the chair off the brake when you wish to move it (See paragraph 3.1. Wheel blocking). **Always move the chair in the low position.**

### Step 11

When you wish to move the chair upwards / downwards, you must apply the brake (See paragraph 3.5. Moving upwards / downwards).

## 3. Operation

### 3.1. Wheel blocking

- The brake can be applied on the Elexo XXL by pushing the gray lip on the wheel downwards (See figure 2).
- To take the Elexo XXL off the brake, the gray lip on the wheel must be pushed upwards again.

### 3.2. Directional wheel

- The standard Elexo XXL comes with a swivel wheel that is fitted to the left front side of the device (See figure 3). The direction of the wheel can be blocked by pushing the green lip on the wheel downwards. This makes it easier to push the device over long distances as the chair is less inclined to move sideways.
- In order to remove the blocking, the green lip on the wheel must be pushed upwards again.

### 3.3. Footrests

- Before the client takes a seat in the Elexo XXL, the footrests must be raised slightly and turned outwards. There is now sufficient room in front of the chair and the client can easily take a seat.
- Once the client has taken a seat, the carer or client raises one leg, the carer then turns the footrest forwards until it falls into the lock. The client can then rest their foot on the support.
- The same procedure is then carried out with the other leg.
- The footrests of the Elexo XXL are adjustable in length. To do this, pull off the tube adjuster and select the desired position. Then push the tube adjuster back onto the frame.

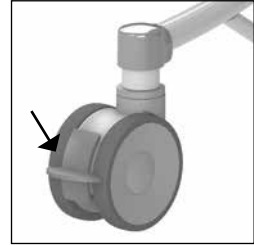

Figure 2 Swivel wheel.

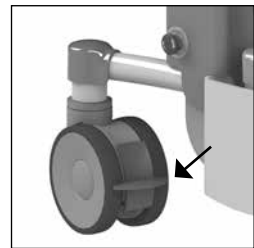

Figure 3 Directional wheel.



Figure 4 Footrest.

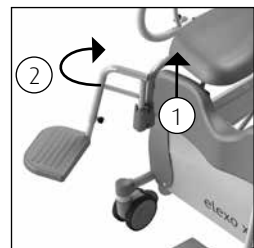

Figure 5 Turning footrest away.



**Always replace this component on the chair when you have finished using it. This will avoid the component being lost.**

### 3.4. Armrests

- The independent, turning armrests are easy to use.
- The safety catch is pulled outwards to unlock the armrest (1) (See figure 6).
- The armrest can now easily be turned to the back (2) (See figures 6 & 7).
- Always protect the client when folding the armrests up or down.
- The armrests can also be used as a support when taking a seat or standing up.

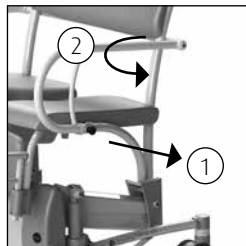

Figure 6 Armsteun.



**When folding the armrests away, avoid the hinging point to prevent possible entrapment.**



**When folding the armrests away, avoid fingers or body parts becoming entrapped between the armrest and the back support.**



**The armrest must not be used as a lever arm (e.g. when moving the chair over an obstacle) or as a push / pull bar. You must not sit on it either. This could damage the Elexo XXL and / or present a hazard.**



Figure 7 Armrest in turned out position.

### 3.5. Moving upwards / downwards

#### *Moving upwards*

- If the client is seated in the chair, first apply the brakes to the wheels and then move the chair upwards.
- Move the chair upwards by pressing the button that shows an 'up' arrow. The seat frame will move up simultaneously (See figure 8).
- You can stop the movement whenever you like by taking your finger off the button.
- During the upward movement, maintain contact with the client.



Figure 8 Moving upwards.



**When moving upwards, the position of the chair will tilt from 0° to a maximum of 20° backwards.**

### *Moving downwards*

- Move the chair downwards by pressing the button that shows a 'down' arrow. The seat of the Elexo XXL will move downwards simultaneously (See figure 9).
- You can stop the movement whenever you like by taking your finger off the button.
- During the downward movement, maintain contact with the client.



Figure 9 Moving downwards.



**Before moving the chair downwards, check to ensure there are no persons or objects in the vicinity of the chair.**

## **3.6. Toilet function**

### *3.6.1. In combination with toilet*

- The Elexo XXL can also be moved over the toilet.
- Once the client has taken a seat and the armrests are closed, the carer must move the Elexo XXL to the appropriate height.
- Move the Elexo XXL, if necessary, upwards or downwards to achieve the right position.
- The Elexo XXL can now be moved backwards over the toilet.
- Lower the Elexo XXL, if necessary, to achieve the right position.



**The Elexo XXL does not fit over every toilet.**

### *3.6.2. Use of a bedpan or bucket*

- If the Elexo XXL is being used as a toilet chair, the special guides under the seat can be used to accommodate a stainless steel / plastic bedpan or bucket.
- The bedpan or bucket is slid in from the back of the chair (See figure 10).
- If you are using the Lopital plastic bedpan, you must slide it as far forwards as possible (See figure 11).
- If you are using a stainless steel bedpan or bucket, the bedpan can be placed in 2 positions under the seat. At the front of the seat (See figure 12) or at the back of the seat (See figure 13).

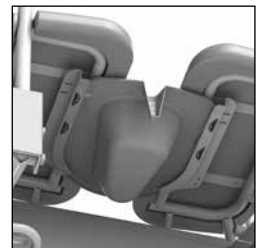

Figure 10 Bedpan.



Figure 11 Lopital plastic bedpan.



**In order to avoid injuries, we advise the carer to place the bucket before the client takes a seat on the chair.**



**The Lopital plastic bedpan, stainless steel bedpan and bucket must be cleaned and disinfected after use, for example in a bedpan washing unit.**



**If the Lopital plastic bedpan, stainless steel bedpan or bucket has been used, it must be removed from the chair before the chair is moved or adjusted in height.**

### 3.7 Removable seat

If required, the seat of the Elexo XXL can be taken off the frame. By doing so, the seat can be cleaned even better. The seat can be taken off the frame without using tools. Pull the seat upwards in the front (See figure 14). To put the seat back, press the seat back onto the frame. Ensure that the seat fits well around the frame.

### 3.8. Charging battery

- The Elexo XXL is an electrically driven high / low shower-toilet chair and works on a battery.
- The charging point is located on the front of the chair, on the blue cover on the underside of the device (See figure 15).
- If the battery is almost completely empty of charge, the orange light on the manual control will come on; this means that the battery needs to be charged.
- If the LED is on continuous red, the battery must be charged immediately. The chair can then no longer be used.
- Connect the charger to the Elexo XXL (See figure 15).
- Once the charger is connected to the Elexo XXL, the controls will go into 'sleep' setting (all functions are switched off).



**Make sure that you push the plug into the correct position in the charging point.**



Figure 12 Stainless steel bedpan, front.

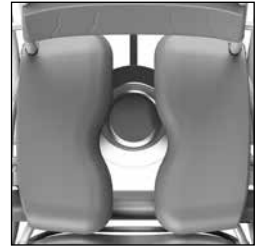

Figure 13 Stainless steel bedpan, back.



Figure 14 Removable seat.

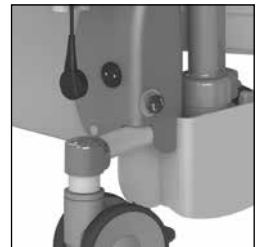

Figure 15 Charging point.



**Only the original charger for the Elexo XXL may be used. If you use another charger, Lopital cannot be held liable for any consequences, such as damage to the electronics.**



**Once the charger is connected to the Elexo XXL, the controls will go into 'sleep' setting (all functions are switched off).**



**The charger that must be used for the Elexo XXL is the 'Mascot 2241'.**

- When the indicator light on the charger goes green, the battery is charged. The charger can remain connected even when the battery is completely charged. Leaving it connected will not cause any damage.
- Disconnect the Elexo XXL from the charger.
- Once activated, the Elexo XXL is now ready for use (See paragraph 2.2. *Activating*).

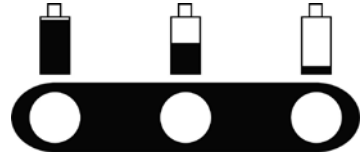

Figure 16 Battery indication on manual control.

- LED not on:** Chair is in 'sleep' setting and cannot be used.
- Green LED is on:** Chair is ready for use.
- Orange LED is on:** Battery needs charging or battery is partially charged.
- Orange LED blinks:** Emergency stop has been activated.
- Red LED blinks:** Battery must be charged (chair can still be used).
- Red LED on:** Battery is completely empty and must be charged immediately.



**Charge battery in a well-ventilated, dry space.**



**After using the chair, connect it to the charger to maintain the battery. Charge the chair at least once a week!**

For instruction videos go to [www.lopital.com](http://www.lopital.com) or [www.youtube.com/user/LopitalNL](http://www.youtube.com/user/LopitalNL)



## 4. Safety functions

### 4.1. Emergency stop

On the left hand side, you will find the emergency stop (See figure 17). Operate this button in an emergency; if the upward or downward movement must be stopped immediately. Once the emergency stop has been pressed, the electronic controls will stop working. Operation may be continued once the situation is stable again. Turn the emergency stop a quarter turn to unlock it again (See figure 18).



**Check whether the danger has passed or the problem has been resolved before resetting the emergency stop.**



**The orange LED light on the manual control will flash when the emergency stop has been activated.**

### 4.2. Sleep setting

After around an hour, the chair will fall into a 'sleep' setting and the battery indication LEDs on the manual control will go out. In order to use the chair again, it must be activated (See paragraph 2.2. Activating).

### 4.3. Emergency lowering

If the controls stop working and the chair is in a raised position, it can be lowered using the emergency lowering button.

Check first to make sure the chair is not in sleep setting!

- Remove the plug from the manual control (1) (See figure 19).
- Press the emergency lowering button (2) (See figure 19).

The chair will now return to the lowest position (make sure no persons or objects are under the chair). Take the client from the chair and make sure the device is not used until it has been repaired. Place the chair in a safe place and indicate that it is out of order.

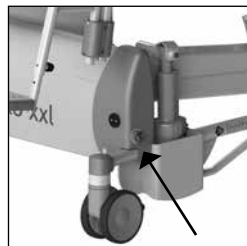

Figure 17 Emergency stop.



Figure 18 Emergency stop.

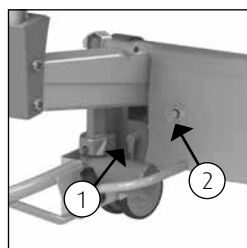

Figure 19 Emergency lowering button.

Contact the technical service or Lopital's service department. E-mail: [info@lopital.nl](mailto:info@lopital.nl)

#### 4.4. On / off switch

On the right hand side of the cover cap, there is the on / off switch (See figure 20). If the chair is out of use for an extended period, you are advised to turn it off. This will prevent any unauthorised use of the chair.

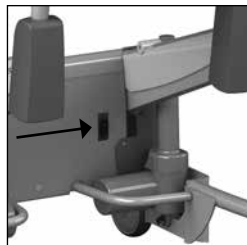



Figure 20 On / off switch.

## 5. Cleaning and maintenance

The Elexo XXL must be cleaned after every use, with water and regular household cleaning agents. PUR integrated foam components with IMC coating should be rubbed clean and disinfected. Do not use any abrasive or other aggressive cleaning products. If necessary, the PUR components can be disinfected with a solution of 70% ethanol or propanol.

The time the products must be left on the components has a significant impact upon the lifespan of the PUR components. As a result of the material properties of PUR, contact with sharp objects must be avoided. This could lead to damage or tears in the material. Finally, we would like to point out that non-critical parts of the PUR components must also be cleaned and disinfected.

Check the wheels regularly for hairs, dust and soap residues and remove when necessary. Maintenance and repairs to the Elexo XXL may only be carried out by authorised personnel.

<b>Maintenance schedule</b>	
<b>After every use</b>	<ul style="list-style-type: none"> <li>• Clean chair with water and regular household cleaning products.</li> <li>• PUR foam components must be cleaned and disinfected.</li> <li>• Check to ensure all parts of the Elexo XXL are present, including the footrests and the manual control.</li> </ul>
<b>Weekly</b>	<ul style="list-style-type: none"> <li>• Check wheels for hairs, dust and soap residues and remove if necessary.</li> <li>• Check that the chair is still working correctly.</li> <li>• Charge the battery at least once a week.</li> </ul>
<b>Annually</b>   <p>The image shows a grey rectangular sticker for Lopital. At the top left is the Lopital logo. Below it is a circular gauge with numbers 1 through 12. The word 'YEAR' is printed in the center of the gauge. A black arrow points to the number 1. To the right of the gauge, the text 'Volgende inspectiedatum:' is written vertically. At the bottom of the sticker, it says 'Service &amp; Onderhoud', 'Tel: +31 (0)13 523 9300', and 'www.lopital.nl'.</p>	<ul style="list-style-type: none"> <li>• According to the regulation MDR (EU) 2017/745 medical devices, a chair must be maintained according to the manufacturer's guidelines. This process will preferably be carried out by Lopital or another authorised body. Lopital offers the option of having the chair thoroughly inspected and serviced once a year via Periodic Preventative Maintenance.</li> </ul> <p>For more information about the maintenance contract, please contact Lopital (<a href="mailto:info@lopital.nl">info@lopital.nl</a>) or speak to your supplier.</p>

For a detailed explanation regarding cleaning and disinfecting, see the document 'Cleaning and Disinfection Protocol' on our website [www.lopital.com/downloads](http://www.lopital.com/downloads).

## 6. Environmental conditions

Conditions during storage and transport

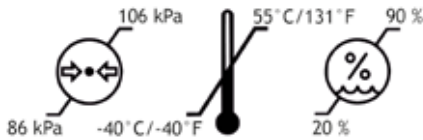

During transport, the seat must be switched off (See paragraph 4.4. On / off switch).

Conditions during use

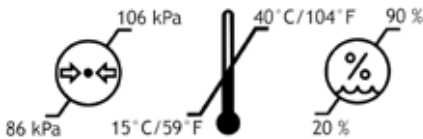

## 7. Removal of parts

All parts that are replaced or removed can be sent back to Lopital BV. You may also offer the parts to the engineer for destruction. We will ensure that all parts are processed in an environmentally-friendly manner.

If you take care of disposal of the product yourself, you must take account of the fact that batteries and chargers must be disposed of as small chemical waste.

## 8. Technical specifications



The Elexo XXL Shower-toilet chair belongs to category 'BF'.



The Elexo XXL Shower-toilet chair is a EMC class 2 product.

The Elexo XXL is splash-proof; this means that the Elexo XXL can be used under the shower. This is given with instruction IPX4.

### 8.1. Structure

Frame:	Stainless steel and steel tubes and plates that are equipped with a two-layer powder coating
Hinge points:	Stainless steel, cover caps made of plastic V0
Wheels:	Plastic, Ø 12.5 cm / 4.9 inch, double blocking facility
Body support:	PUR (polyurethane).
Weight:	71 kg / 165 lbs
Maximum permitted load:	220 kg / 485 lbs

### 8.2. Drive

Drive:	2 x actuator 24V DC Push Only 8000N
Battery:	2 x battery capacity 7Ah
Charger:	110-240AC, 50/60Hz, max 0,35A, cable length 2.8 m

### 8.3. Dimensions

Surface area:	89 cm / 36 inch wide, 114 cm / 44.9 inch deep
Seat height:	Adjustable: minimum 50 cm / 19.7 inch, maximum 105 cm / 41.3 inch

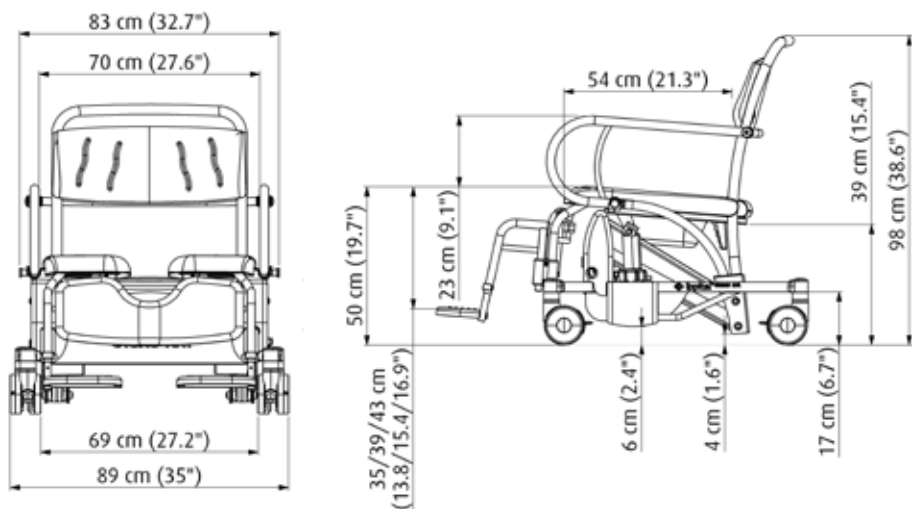
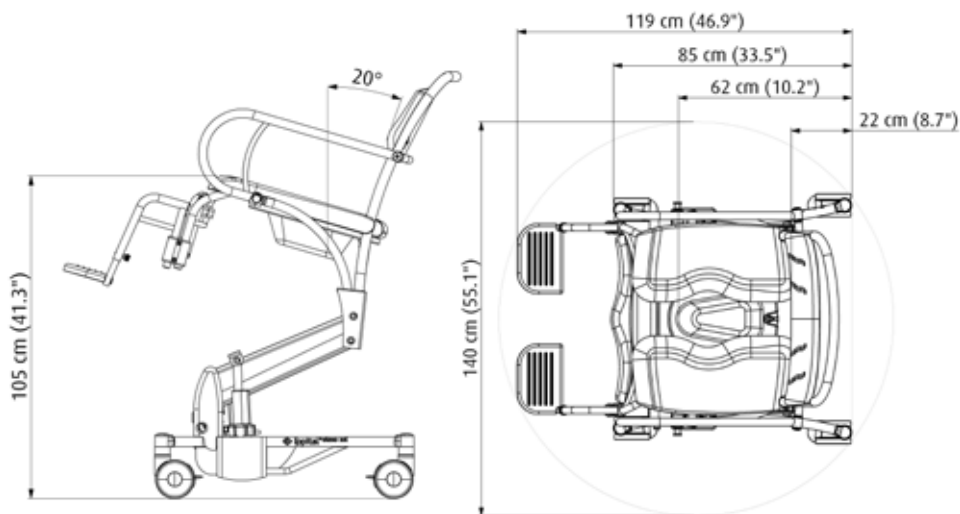

**Manufacturer's Declaration of Conformity**  
CE marking in accordance with the Medical Device Regulation

**Brand name:** Lopital  
**Medical device:** Elexo XXL  
**Device description:** Mobile shower-/toilet chair with electrically adjustable height  
**Models:** 51005300  
**Classification:** Class I  
**Basic UDI-DI:** 872025610316551005300JX  
**Conforms to regulation:** Medical Device Regulation (EU) 2017/745



**Standards applied:** NEN-EN-ISO 14971:2019 | *Medical devices-Application of risk management to medical devices*  
NEN-EN 12182:2012 | *Assistive product for persons with disability-General requirements and test methods*  
ISO 17966:2016 | *Assistive products for personal hygiene that support users-Requirements and test methods*  
IEC 60529:2019 | *Degrees of protection provided by enclosures (IP Code)*  
IEC 60601-1:2005 + A1:2012 | *Medical electrical equipment - Part 1: General requirements for basic safety and essential performance*  
IEC 60601-1-2:2007 | *Medical electrical equipment - Part 1-2: General requirements for basic safety and essential performance - Collateral Standard: Electromagnetic disturbances - Requirements and tests*  
IEC 60601-1-6:2010 | *Medical electrical equipment - Part 1-6: General requirements for basic safety and essential performance - Collateral standard: Usability*  
IEC 62366:2007 | *Medical devices - Application of usability engineering to medical devices*  
CAN/CSA-C22.2 No. 60601-1:14 | *Medical electrical equipment - part 1: General requirements for basic safety and essential performance*  
ANSI/AAMI ES60601-1:2005/A2:2010/(R)2012 | *General requirements for basic safety and essential performance*  
UNI-CEI-EN-ISO 13485:2016 | *Medical devices-Quality management systems-Requirements for regulatory purposes*  
NEN-EN-ISO 9001:2015 | *Quality management systems - Requirements*  
NEN-EN-ISO 14001:2015 | *Environmental management systems - Requirements with guidance for use*

**Certificate/report no.:** Certificate: NL-36630  
Reports: 2176154.50 (A,B,C,D), 2176154.0502-EMC

**Authorised signatory, Cees van Dam, director:**

**Signature:**



**Date:**

2021-05-03

**Place:**

Oisterwijk

# 9. Electromagnetic compatibility

Guidance and Manufacturer's declaration-electromagnetic emissions		
The Elexo XXL is intended for use in the electromagnetic environment specified below. The customer or the user of Elexo XXL should assure that it is used in the following environment:		
Emissions Test	Compliance	Electromagnetic Environment - guidance
RF emissions CISPR11	Group 1	The Elexo XXL uses RF energy only for its internal function. Therefore, its RF emissions are very low and are not likely to cause any interference in nearby electronic equipment.
RF emissions CISPR11	Class B	The Elexo XXL is suitable for use in all establishments, including domestic establishments and those directly connected to the public low-voltage power supply network that supplies buildings used for domestic purposes.
Harmonic emissions IEC 61000-3-2	Class A	
Voltage Fluctuations/ Flicker emissions IEC 61000-3-3	Complies	

Guidance and Manufacturer's declaration-electromagnetic immunity			
The Elexo XXL is intended for use in the electromagnetic environment specified below. The customer or the user of the Elexo XXL should assure that it is used in the following environment:			
Immunity Test	IEC 60601-1-2 Test Level	Compliance Level	Electromagnetic Environment - guidance
Electrostatic discharge (ESD) IEC 61000-4-2	±6 kV contact ±8 kV air	±6 kV contact ±8 kV air	Floors should be made of wood, concrete, or ceramic tile. If floors are covered with synthetic material, the relative humidity should be at least 30%.
Electrical fast transient/ burst IEC 61000-4-4	±2 kV for power supply lines ±1 kV for input/ output lines	±2 kV for power supply lines ±1 kV for input/ output lines	Mains power quality should be that of a typical commercial or hospital environment.
Surge IEC 61000-4-5	±1 kV line(s) to line(s) ±2 kV line(s) to earth	±1 kV line(s) to line(s) ±2 kV line(s) to earth	Mains power quality should be that of a typical commercial or hospital environment.
Voltage dips, short interruptions, and voltage variations on power supply input lines IEC 61000-4-11	<5% Un (>95% drop in Un) for 0,5 cycle  40% Un (60% drop in Un) for 5 cycles  70% Un (30% drop in Un) for 25 cycles  <5% Un (>95% drop in Un) for 5 seconds	<5% Un (>95% drop in Un) for 0.5 cycle  40% Un (60% drop in Un) for 5 cycles  70% Un (30% drop in Un) for 25 cycles  <5% Un (>95% drop in Un) for 5 seconds	Mains power quality should be that of a typical commercial or hospital environment. Elexo XXL is equipped with a battery.
Power frequency (50/60 Hz) magnetic field IEC 61000-4-8	3 A/m	3 A/m	Power frequency magnetic fields should be at levels characteristic of a typical location in a typical commercial or hospital environment.
<b>NOTE</b> Un is the a.c. mains voltage prior to application of the test level			



Guidance and Manufacturer's declaration-electromagnetic immunity			
The Elexo XXL is intended for use in the electromagnetic environment specified below. The customer or the user of the Elexo XXL should assure that it is used in the following environment:			
Immunity Test	IEC 60601-1-2 Test Level	Compliance Level	Electromagnetic Environment - guidance
RF Common mode/ Conducted Susceptibility IEC 61000-4-6  Radiated RF Electromagnetic Field IEC 61000-4-3	3 Vrms 150 kHz to 80 MHz  3 V/m 80 MHz to 2,5 GHz	3 V  3 V/m	<p>Portable and mobile RF communications equipment should be used no closer to any part of the Elexo XXL, including cables than the recommended separation distance calculated from the equation applicable to the frequency of the transmitter. Recommended separation distance.</p> <p><math>d = 1,2 \sqrt{P}</math></p> <p><math>d = 1,2 \sqrt{P}</math> 80 MHz to 800 MHz</p> <p><math>d = 2,4 \sqrt{P}</math> 800 MHz to 2,5 GHz</p> <p>Where P is the maximum output power rating of the transmitter in watts (W) according to the transmitter manufacturer and d is the recommended separation distance in meters (m).</p> <p>Field strengths from fixed RF transmitters, as determined by an electromagnetic site survey,<sup>a</sup> should be less than the compliance level in each frequency range.<sup>b</sup></p> <p>Interference may occur in the vicinity of equipment marked with the following symbol:</p> 
<p><b>NOTE 1</b> At 80 MHz and 800 MHz, the higher frequency range applies.</p> <p><b>NOTE 2</b> These guidelines may not apply in all situations. Electromagnetic propagation is affected by absorption and reflection from structures, objects and people.</p>			
<p><b>a</b> Field strengths from fixed transmitters, such as base stations for radio (cellular/cordless) telephones and land mobile radios, amateur radio, AM and FM radio broadcast and TV broadcast cannot be predicted theoretically with accuracy. To assess the electromagnetic environment due to fixed RF transmitters, an electromagnetic site survey should be considered. If the measured field strength in the location in which the Elexo XXL is used exceeds the applicable RF compliance level above, the Elexo XXL should be observed to verify normal operation. If abnormal performance is observed, additional measures may be necessary, such as re-orienting or relocating the Elexo XXL.</p> <p><b>b</b> Over the frequency range 150 kHz to 80 MHz, field strengths should be less than 3 V/m.</p>			

**Recommended separation distance between  
portable and mobile RF communications equipment and the Elexo XXL**

The Elexo XXL is intended for use in the electromagnetic environment in which radiated RF disturbances are controlled. The customer or the user of the Elexo XXL can help prevent electromagnetic interference by maintaining a minimum distance between portable and mobile RF communications equipment (transmitters) and the Elexo XXL as recommended below, according to the maximum output power of the communications equipment.

Rated maximum output power of transmitter  W	Separation distance according to frequency of transmitter		
	m		
	150 kHz to 80 MHz	80 MHz to 800 MHz	800 MHz to 2,5 GHz
	$d = 1,2 \sqrt{P}$	$d = 1,2 \sqrt{P}$	$d = 2,4 \sqrt{P}$
0,01	0,12	0,12	0,24
0,1	0,38	0,38	0,76
1	1,2	1,2	2,4
10	3,8	3,8	7,6
100	12	12	24

For transmitters rated at a maximum output power not listed above, the recommended separation distance  $d$  in meters (m) can be estimated using the equation applicable to the frequency of the transmitter, where  $P$  is the maximum output power rating of the transmitter in watt (W) according to the transmitter manufacturer.

**NOTE 1** At 80 MHz and 800 MHz, the separation distance for the higher frequency range applies.

**NOTE 2** These guidelines may not apply in all situations. Electromagnetic propagation is affected by absorption and reflection from structures, objects and people.

